



Summary

GENERALITIES

- Introduction	2
- Applications	3
- Advantages	3
- Production	4
- Quality assurance	5
- Design/ Research and development	5
- Shielding expertise	6

DETAILED CHARACTERISTICS OF FLAT FLEXIBLE CABLES

- General drawing of a FFC	8
- Pitches	8
- Product code for flat flexible cables AXOJUMP®	9
- Types of stripping and connection	10
- Types of reinforcement	13
- Connection	16
- Insulation tapes and marking	17
- Conductors	19
- Flex life	21
- Dimensions	22
- Shielding	23

SPECIAL PRODUCTS

- Folds	25
- Punching	25
- Notches	25
- Slitting	26
- Specific markings	26
- Other custom options	26

Generalities

AXOJUMP® : FLAT FLEXIBLE CABLES FFC

Designed for board-to-board interconnections AXOJUMP® flat flexible cables are made up of flat conductors insulated with Polyester or Polyimide tapes.

Termination is made

- either with ZIF (Zero Insertion force) /LIF (Low Insertion Force) connectors : the cables are equipped with reinforcement tape to strengthen the ends,
- or by soldering,
- or with crimped contacts.

GENERAL DRAWING OF A FFC

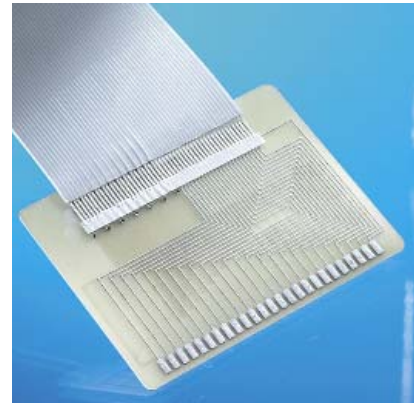
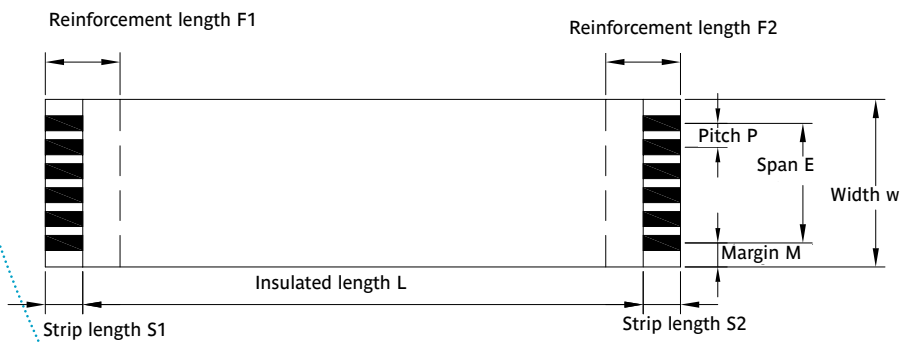

▲ SOLDERING



▲ CRIMPED CONTACTS



▼ LIF CONNECTOR

APPLICATIONS

AXOJUMP® flat cables can be used in numerous application areas :

- IT equipment
notebooks, scanners, printers ...
- Consumer electronics
CD and DVD players, video recorders,
TV, various displays, hi-fi systems,
satellite receivers and decoders,
- Telecommunications
telephones, fax machines ...
- Automotive industry
car radios, GPS systems ...
- House hold equipment
glass-ceramic cooking plates,
refrigerators, dishwashers ...
- Military electronics
missiles, weapon systems ...
- Etc.

ADVANTAGES

AXOJUMP® flat cables offer many advantages :

- Extremely small dimensions :
low profile - narrow width -
small pitch.
- Simple and fast installation :
Time saving - cost reduction.
- Compatible with ZIF/LIF
connectors.
- Very good flex life.

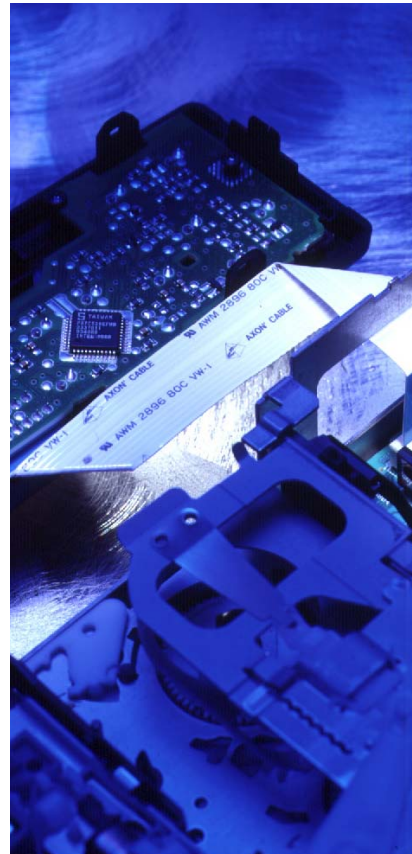

▲ CAR RADIO

PRODUCTION

AXOJUMP® Flat Flexible Cables are manufactured in AXON's production sites in Europe, America and Asia, using state-of-the-art mass production technology.

AXON' masters FFC manufacturing from wire drawing, plating and rolling of conductors to insulation, final cutting and shielding.

● Conductor manufacturing

AXON' manufacture their own flat conductors. The main materials used are :

- Bare copper,
- Tin plated copper,
- Silver plated copper,
- Gold plated copper.

All these conductors are lead free.

AXON's expertise in laminating and cutting conductors allows for a wide range of flat cables with different levels of flexibility.

The very modern manufacturing equipment allows perfect dimensional precision, electrical resistance control and production of long continuous lengths.

● Cable insulation

AXON' insulates the conductors with laminated Polyester or Polyimide tapes. Depending on the requested type of connection – removable, irremovable or mixed – the cables are equipped with reinforcements and/ or (pre-) stripped (see page 10 « types of stripping and connection »).

Dimensional characteristics of the cables – pitch, margin, width, span, insulated length – are checked.



▲ FLAT COPPER CONDUCTOR



▲ FLAT CABLE INSULATION



▲ FLAT CABLE WORKSHOP

QUALITY ASSURANCE

AXON' has obtained approvals such as

- ISO 9001 : 2000,
- ISO TS 16949,
- ISO 14001.

AXON's triennial continuous improvement plan called "SOLON CIP" is based on EFQM (European Foundation for Quality Management).

In addition to in line controls throughout the manufacturing area AXON' applies "Statistical Process Control" methods (SPC) as well as standard problem solving and continuous improvement methods. TPM (Total Productive Maintenance) is applied in order to improve productivity.

The whole standard AXOJUMP® product range is compliant to the European RoHS 2002/95 WEEE 2002/96 instruction.

In addition, AXON' has been recorded since 2003 in the « International Material Data System (IMDS) » which indicates the making-up of the products.

DESIGN / RESEARCH AND DEVELOPMENT

At the company's headquarters, as well as in each country where AXON' has a subsidiary – Germany, Great Britain, USA, Latvia, Hungary, China – engineering teams assure local technical support.

The Research and Development Department located in France concentrates on the following areas :

- Metal technology
 - Metal plating of the conductors,
 - Drawing - Annealing.
- Plastic technology
 - Insulation - Jacketing,
 - Molding - Overmolding.
- Electronics
 - EMI/EMC,
 - Data transmission.
- Interconnection technology
 - Soldering,
 - Welding,
 - Crimped contacts.



▲ IN LINE CONTROLS

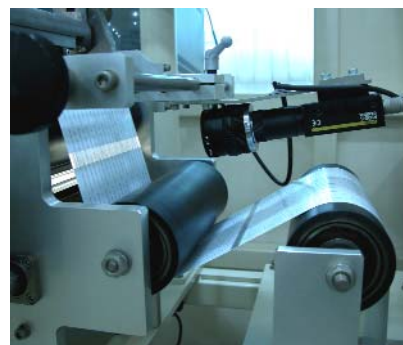

▲ IN LINE CONTROLS



▲ ENGINEERING DEPARTMENT

SHIELDING EXPERTISE

AXON' offers two types of shielded flat cables :

- Cables shielded with aluminium tape, grounded and ungrounded (pitch 1.00 mm and above).
- Cables shielded by a conductive silver painting and a protection varnish, also available with grounding(s).

To characterize the shielding of flat or round cables AXON' uses the "transfer impedance Z_T " parameter given in ohms/m. As this notion depends on the type of product, rather than on the application, it is better suited than the alternative notion of "shielding efficiency", given in dB, to define shield specifications accurately.

AXON' is equipped with comprehensive test benches to characterize transfer impedance of round and flat cables as well as terminated harnesses. The flat cables are generally measured using a microstrip or strip line.

In order to propose the shielding solution best suited to each application AXON' has compared the shielding resistance of flat cables shielded with Aluminum foils as well as flat cables shielded with a conductive painting. The cables are measured before and after flex test.

The following references have been chosen for the test :

- 1.00 mm pitch FFC shielded with aluminum foil, shield connected,
- 1.00 mm pitch FFC shielded with conductive painting, shield connected,
- 0.50 mm pitch FFC shielded with Aluminum foil, shield not connected,
- 0.50 mm pitch FFC shielded with conductive painting, shield connected.

● Measurement of the shield resistance

- Shield resistance is measured on a network analyzer using microstrip method.
- The connection between the flat cable and the coaxial cable of the network analyser is made possible by an interface PCB linking the flat cable's ZIF connectors to the coaxial connectors.

● Flex test

The cables flex at a speed of 100 cycles / minute for 500 000 cycles with a bend radius of 10 mm.

The following graphs show the transfer impedance of the four tested cables, before and after flexing. The lower the transfer impedance the more efficient the shielding will be.

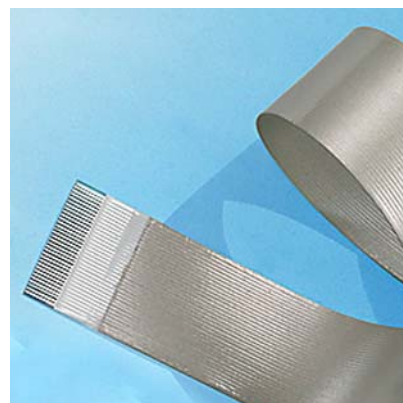

▲ SHIELDING WITH A CONDUCTIVE SILVER PAINTING



▲ MICROSTRIP INJECTION TEST BENCH TO CONTROL TRANSFER IMPEDANCE

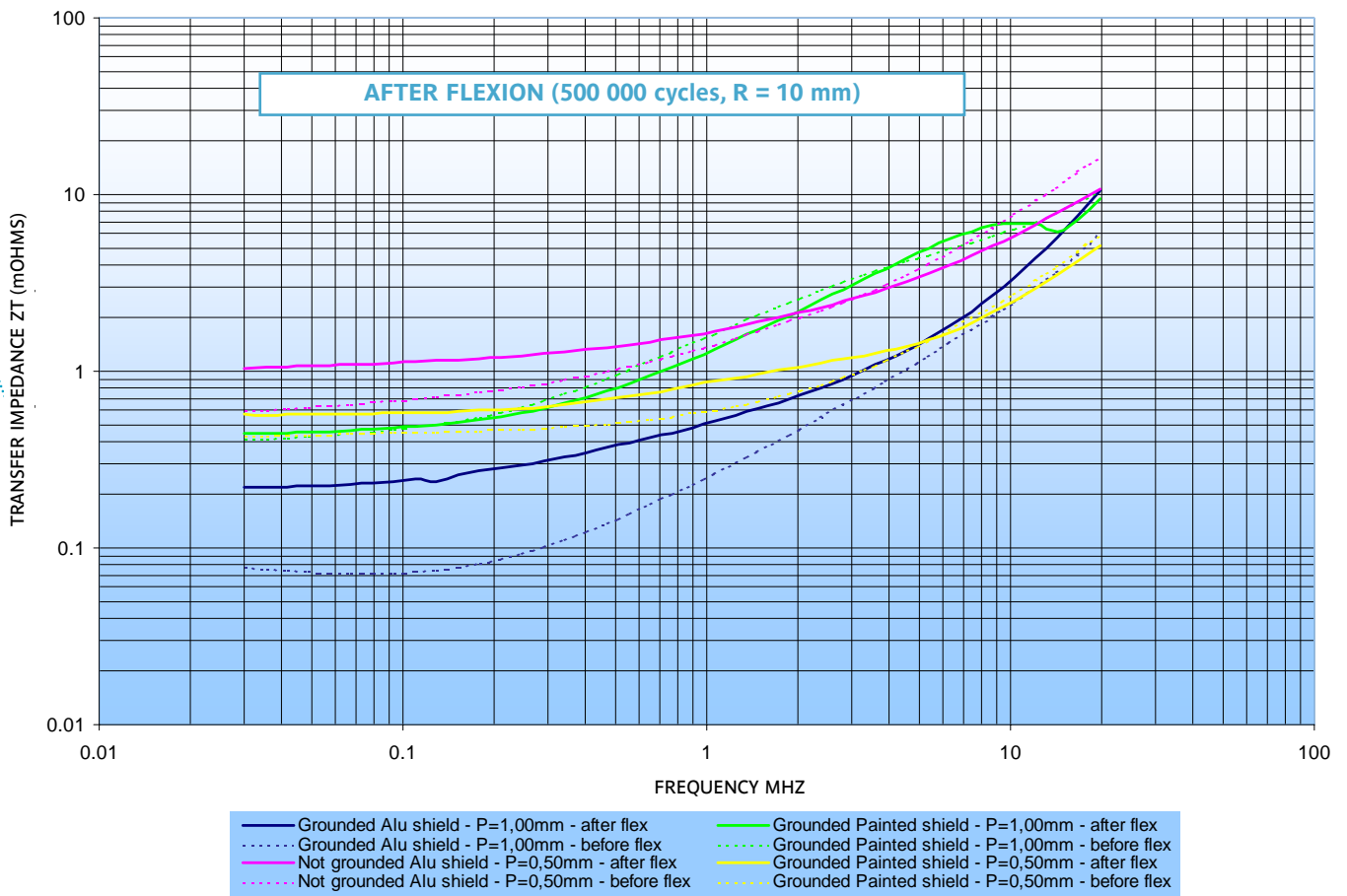
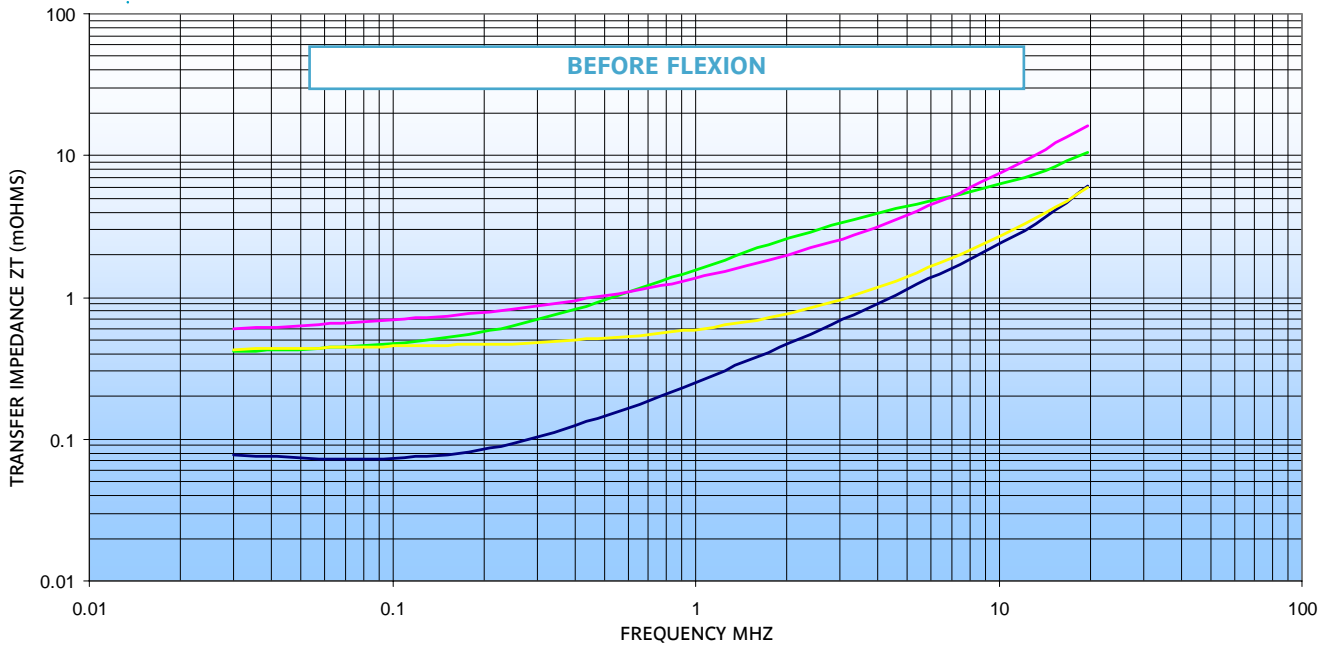

Detailed characteristics

PITCHES

The standard range of AXOJUMP® flexible flat cables consists of the following pitches :

- 0.30 mm
- 0.50 mm
- 0.80 mm
- 1.00 mm
- 1.25 mm
- 1.27 mm
- 2.54 mm

Other pitches can be manufactured upon request.

GENERAL DRAWING OF A FFC

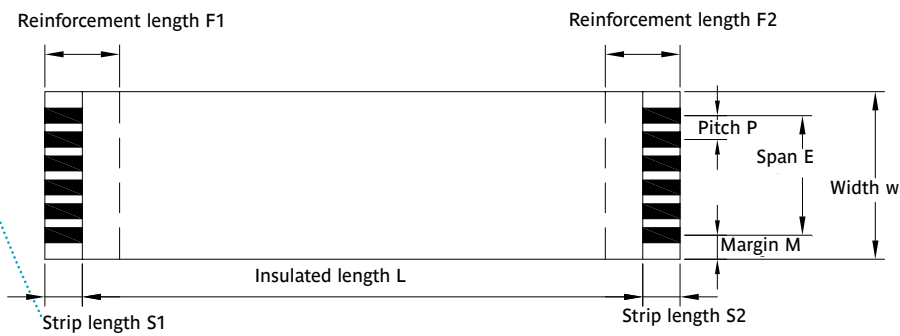

▲ SAME NUMBER OF CONDUCTORS BUT DECREASING PITCH



▲ DIFFERENT PITCHES

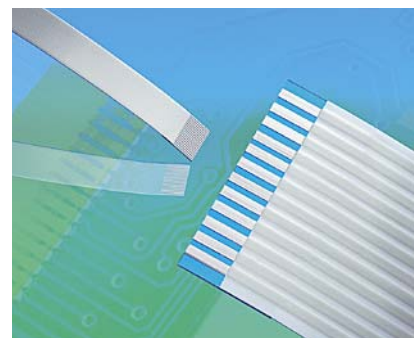

▲ 0.3 mm PITCH VERSUS 2.54 mm PITCH

PRODUCT CODE FOR FLAT FLEXIBLE CABLES AXOJUMP®

FFC 1.00 A 20/ 0075 S 5.0-5.0- 10.0-10.0 F A BB/ G 2-7

Option

S : Aluminium shielding without grounding
G : Grounded Aluminium shielding + # of grounded conductors
PS : Painted shielding without grounding
PG : Painted shielding with grounding + # of grounded conductors (see details page 23)
AU : Gold plated contacts
M : Ink-jet marking
N : Notches, punchings
L : Labels stuck on the cable
F1 : Foldings + # of folds
R1 : Marking of a line on the reinforcements
V1 : Additional reinforcement foil + # of additional reinforcements

Type of reinforcement F1 and F2

B : Blue Polyester
R : Red Polyester
W : White Polyester
H : Polyimide
P : Polyester « Pull-up » type
E : Polyester « Easy-to-insert » type
X : Pre-stripping
 - : No reinforcement
 (see details page 13)

UL marking of the insulation tape

A : tape without UL marking
B : tape with UL marking (see details page 18)

Type of conductor

S : static
F : flexible (50 µm)
E : extra-flexible (35 µm)
U : ultra-flexible (25 µm) (see details page 19)

Reinforcement length F1 and F2 in mm

Strip length S1 and S2 in mm

Type of insulation tape : S / E / L / H / P / M / N / T / X / Y / Z
 (see details page 17)

Insulated length in mm

Number of conductors

Type of stripping

A : one reinforcement at each end on the same side of the FFC
B : one single reinforcement
C : no reinforcement
D : one reinforcement at each end on opposite sides of the FFC (see details page 10)

Pitch in mm : 0.3 / 0.5 / 0.8 / 1.00 / 1.25 / 1.27 / 2.54

Flat Flexible Cable (see table of dimensions page 22)

TYPES OF STRIPPING AND CONNECTION

Each type of stripping has its own letter code : A, B, C or D (see page 11-12). For each end a strip length (S1, S2), a type of reinforcement (see page 13) and a reinforcement length (F1, F2) will be defined.

Example of reference :

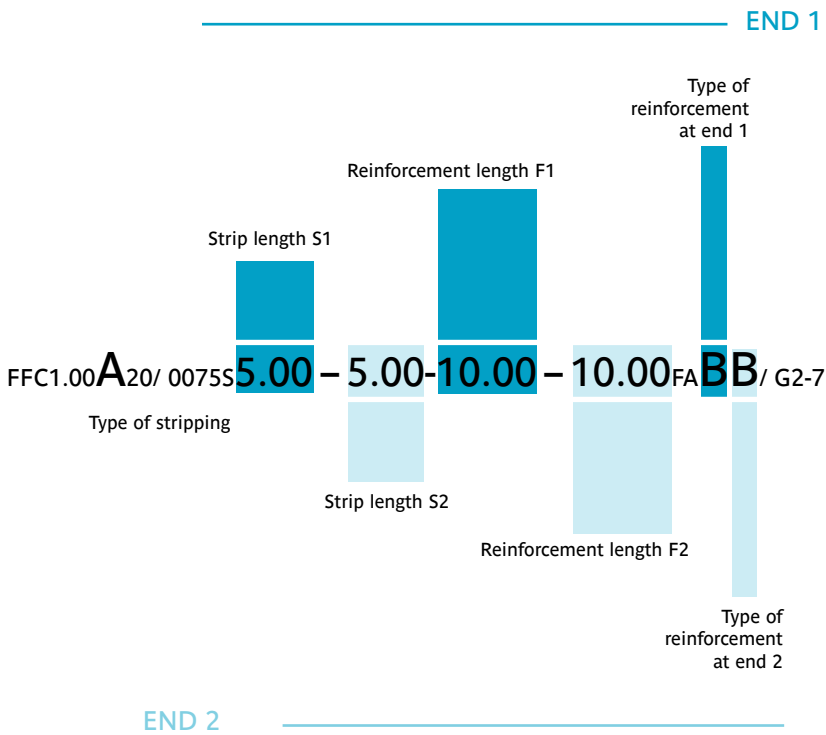

▲ DIFFERENT TYPES OF STRIPPING AND REINFORCEMENT TYPES

● Type A

REINFORCEMENTS F1 AND F2 AT BOTH ENDS OF THE CABLE, ON THE SAME SIDE

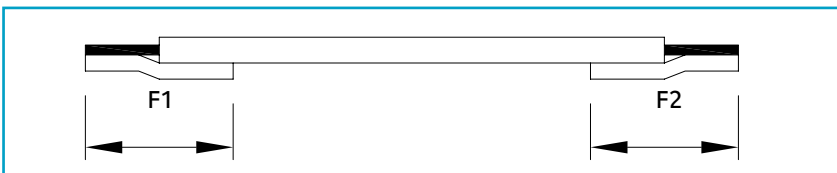

Example of reference : FFC1.00A20/0075S5.0-5.0-10.0-10.0FA RR

Removable connection (connector/connector)

- 2 Polyester reinforcements, standard or "easy-to-insert" version.

Removable connection (solder/solder)

- 2 Polyimide or Polyester "pull-up" reinforcements.

Mixed connection (connector/solder)

- Soldering at one end : use of Polyester "pull-up" or Polyimide reinforcement.
- Removable at the other end (connector) : use of a Polyester reinforcement, standard or "easy-to-insert" version.

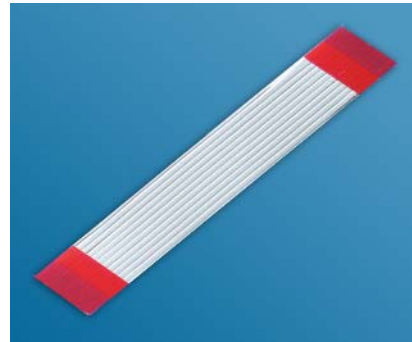

▲ FFC, TYPE A

● Type B

ONE SINGLE REINFORCEMENT F1 AT ONE END / NO REINFORCEMENT AT THE OTHER

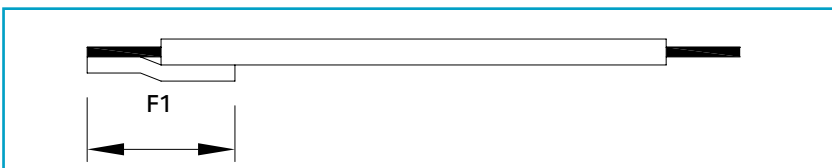

Example of reference : FFC1.00B20/0075S5.0-5.0-10.0-00.0FA B-

(Pre-stripped version : FFC1.00B20/0075T5.0-5.0-10.0-00.0SA BX)

Mixed connection (connector / solder)

- Soldering at one end : stripping or pre-stripping.
- Removable at the other end (connector) : use of a Polyester reinforcement, standard or "easy-to-insert" version.

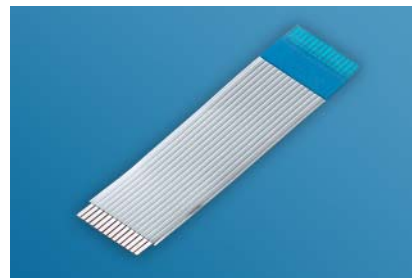

▲ FFC, TYPE B - STRIPPED VERSION



▲ FFC, TYPE B - PRE-STRIPPED VERSION

● Type C

NO REINFORCEMENT

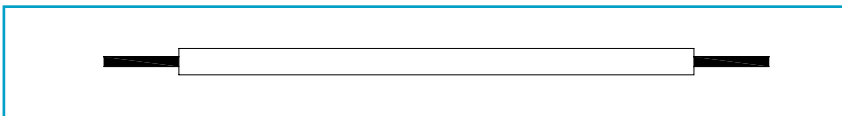

Example of reference : FFC1.00C20/0075S5.0-5.0-00.0-00.0FA--

(Pre-stripped version : FFC1.00C20/0075T5.0-5.0-00.0-00.0SAXX)

Solder connection

Stripping (without reinforcement) or pre-stripping at both ends.

Note : The conductors are not protected and fragile. They may be damaged during shipment and storage. AXON' recommends the use of pull-up reinforcements on both ends to protect the conductors.



▲ FFC, TYPE C - PRE-STRIPPED VERSION



▲ FFC, TYPE C - STRIPPED VERSION

● Type D

2 REINFORCEMENTS F1 AND F2 AT BOTH ENDS ON OPPOSITE SIDES.

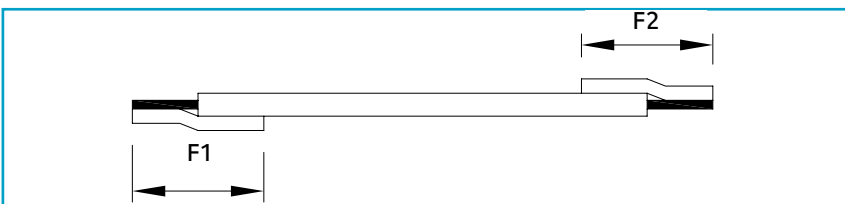

Example of reference : FFC1.00D20/0075S5.0-5.0-10.0-10.0FABB



▲ FFC, TYPE D

Removable connection (connector/connector)

- 2 Polyester reinforcements, standard or "easy-to-insert" version.

Solder connection (solder/solder)

- 2 Polyimide or Polyester "pull-up" reinforcements.

Mixed connection (solder / connector)

- Soldering at one end : use of a Polyester "pull-up" or Polyimide reinforcement.
- Removable at the other end (connector) : use of a Polyester reinforcement, standard or "easy-to-insert" version.

TYPES OF REINFORCEMENT

● Polyester reinforcement

for termination to connectors.

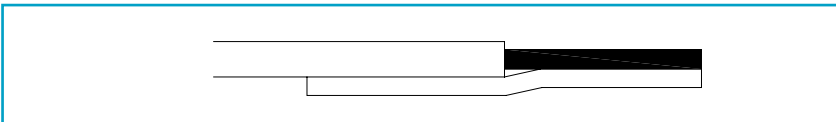

- **Version B** : blue Polyester tape.
- **Version R** : red Polyester tape.

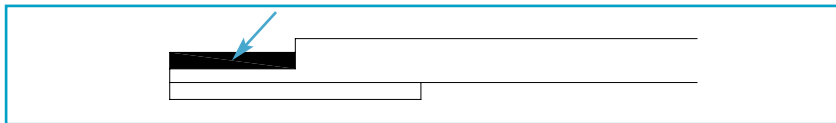

- **Version W** : White Polyester tape, mainly for 0.3 mm and 0.5 mm pitches FFC. The insulation tape remains between conductor and reinforcement tape.

● "Pull-up" reinforcement

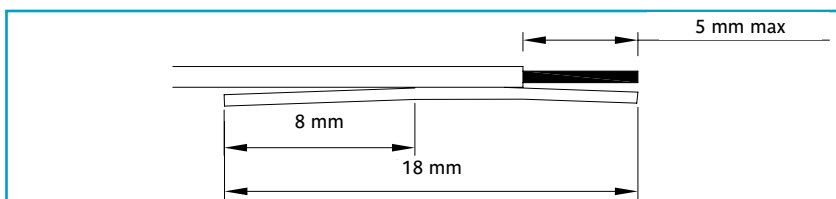

- **Version P** : Clear adhesive tape with "AXON' PULL-UP" marking, used to protect the conductors during transportation. This tape is stuck on a length of max. 5 mm on the insulated cable and can easily be removed before use.

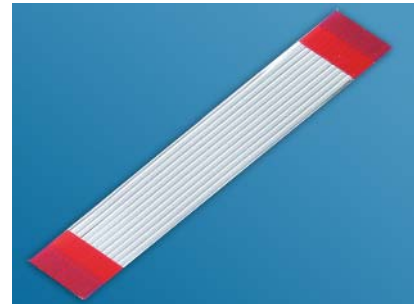

▲ FFC, TYPE R REINFORCEMENT



▲ FFC - TYPE B REINFORCEMENT



▲ FFC - TYPE P REINFORCEMENT

● "Easy-to-insert" reinforcement

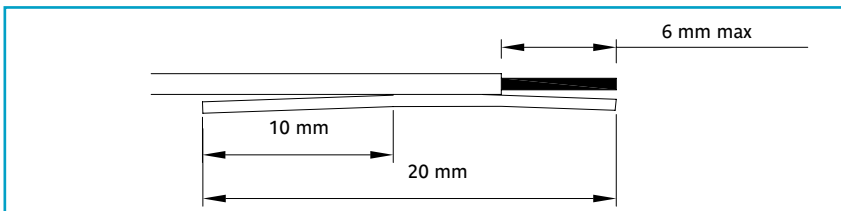

- **Version E** : Polyester reinforcement only partly stuck to the cable to ease installation.



▲ FFC , TYPE E REINFORCEMENT

● Polyimide reinforcement

for thermal protection during hot bar soldering operation.



- **Version H** : Polyimide - natural color (amber).



▲ FFC , TYPE H REINFORCEMENT

● Pre-stripping

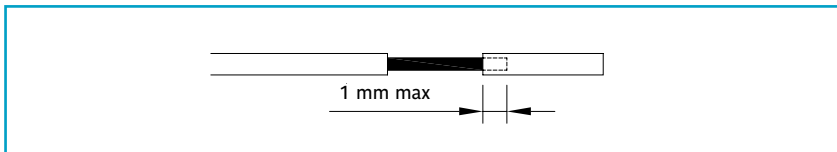

● **Version X** : a short length of insulation remains on the conductor for protection during transportation. The overlapping length of the insulation tape on the conductor is of about 1 mm. Pre-stripping is offered on B and C stripping types and is only possible with T insulation tape (see page 17) and for 1.00 mm and 2.54 mm pitches with static conductors.



▲ FFC , TYPE X PRE-STRIPPED VERSION

● End without reinforcement

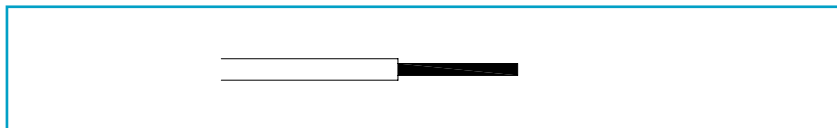

● Version “-” stripped conductors

Note : the conductors are not protected and fragile. They may be damaged during shipment and storage. AXON' recommends the use of pull-up reinforcements or both ends to protect the conductors.



▲ FFC , TYPE “-” STRIPPED VERSION

● Summary of reinforcement tapes

TYPE OF REINFORCEMENT	VERSION	MATERIAL	THICKNESS (mm)	COLOR
STANDARD	B	POLYESTER	0.23	BLUE
STANDARD	R	POLYESTER	0.23	RED
STANDARD	H	POLYIMIDE	0.04	NATURAL (AMBER)
STANDARD	W	POLYESTER	0.10	WHITE
PULL-UP	P	POLYESTER	0.11	CLEAR WITH AXON' MARKING
EASY-TO-INSERT	E	POLYESTER	0.23	BLUE

CONNECTION

● Connection with connectors

AXON' flat cables can be terminated to LIF (low insertion force) or ZIF (zero insertion force) connectors from most connector manufacturers (ELCO / FCI / HIROSE / JAE / JST / MOLEX / TYCO / ...)

● Connection with crimped contacts

2.54 mm pitch FFC's can be terminated to crimp contacts.

● Connection by soldering

Reflow soldering is suited for termination of flat cables onto printed circuit boards.

AXON' uses a semi-automatic process for hot bar soldering to manufacture FFC/ PCB connections. The two parts are assembled using a hot thermode.

● Possible PCB types

- Tin thickness on the soldering pads :
0.5 to 8 mm,
for 0.5 and 0.8 mm pitch FFC.
0.10 to 15 mm,
for 1.00 and 2.54 mm pitch FFC.
- Tinning material : tin-copper alloy.

● Possible FFC types

This process can be used for the following types of FFC :

- All pitches.
- Static, flexible (50 μ m) or extra flexible (35 μ m) conductors.
- Pre-stripped or stripped version, Polyimide insulation or reinforcement.

AXON' also uses these techniques to manufacture flat display connections (product range AXOLINK[®], FDC) made of flat flexible cables and type DF9 connectors.



▲ FLAT DISPLAY CONNECTION

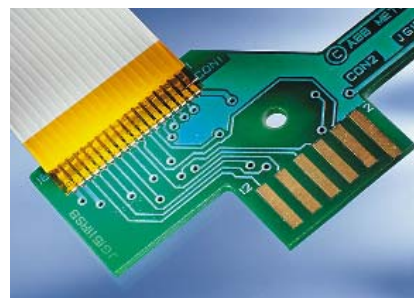

▲ CONNECTION BY SOLDERING

THE PROCESS IS AS FOLLOWS

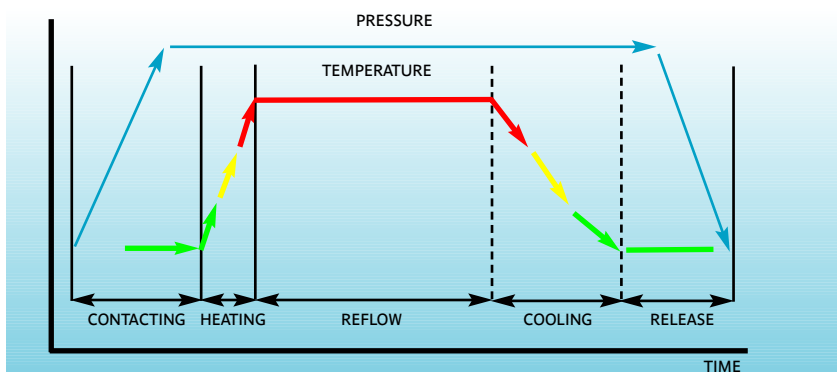

INSULATION TAPES AND MARKING

AXON' offers flat cables with insulation tapes of different thicknesses according to the required flexibility, temperature resistance, color and marking.

Example of reference : FFC1.00A20/0075 **S**5.0-5.0-10.0-10.0F**A**BB

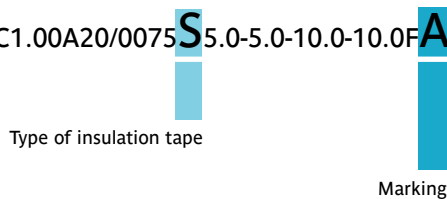

▲ UL MARKING

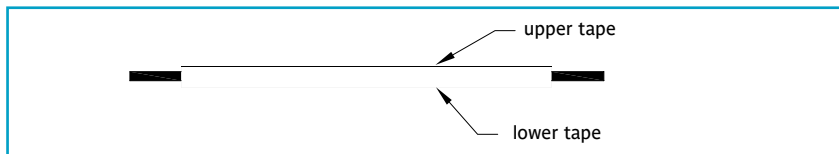

TYPE OF TAPE	COMPATIBLE PITCHES (mm)	MATERIAL	THICKNESS (mm)	COLOR	MARKING*
S (STANDARD)	0.3 TO 2.54	POLYESTER	0.086	WHITE	UL 20706 marking available in 2007
E	0.5 TO 1.27	POLYESTER	0.043	WHITE	No marking
T (FOR PRESTRIPPED VERSIONS)	1.0 TO 2.54	POLYESTER	0.110	WHITE WHITE	No marking UL 2896 marking
L	0.5 TO 2.54	POLYESTER	0.115	WHITE WHITE	No marking UL 2896 marking
H		POLYESTER	0.10	WHITE	No marking
P		POLYESTER	0.105	WHITE WHITE	No marking UL 20624 marking
M		POLYESTER	0.112	BLACK	No marking
N		POLYESTER	0.050	BLACK	No marking
X		POLYIMIDE	UPPER TAPE 0.075	NATURAL (AMBER) OPAQUE	No marking -
		POLYIMIDE	LOWER TAPE 0.04	NATURAL (AMBER) CLEAR	No marking -
Y		POLYIMIDE	0.04	NATURAL (AMBER)	No marking
Z	POLYIMIDE	0.075	NATURAL (AMBER)	No marking	



▲ POLYIMIDE INSULATION : UPPER TAPE OPAQUE/ LOWER TAPE CLEAR ; INK-JET MARKING

*Please also refer to the table "conductor / tape combinations" page 20.

INSULATION TAPES AND MARKING

AXON' can offer FFC's compliant to different UL styles shown in the table below. Do not hesitate to contact us.

UL STYLE	VOLTAGE	TEMPERATURE (*)
UL STYLE 2896	30 V A.C.	80°C
UL STYLE 2643	300 V A.C.	105°C
UL STYLE 20566	90 V A.C.	105°C
UL STYLE 20624	60 V A.C.	80°C
UL STYLE 20696	30 V A.C.	80°C
UL STYLE 20706	60 V A.C.	105°C

AXOJUMP® flat cables can be used at freezing temperatures reaching -40°C.

MARKING

- **Version A** = use of two tapes without marking
- **Version B** = use of one tape with marking (if originally marked tape available - see table above) and one tape without UL marking
In general, the stripped side will be marked.
Specific markings can be studied upon request.

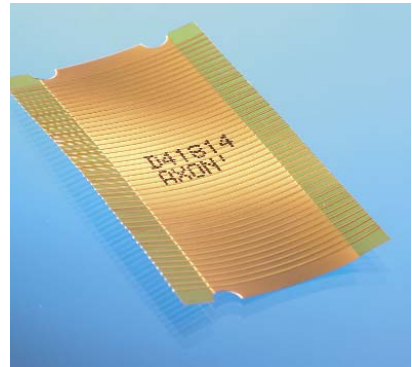

▲ INK-JET MARKING



▲ ORIGINALLY MARKED TAPE
UL STYLE AND AXON' LOGO

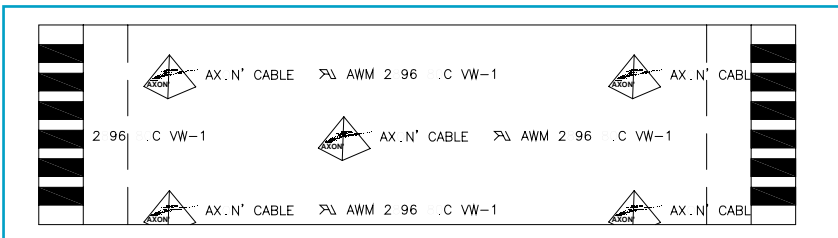

CONDUCTORS

Example of reference : FFC1.00A20/0075S5.0-5.0-10.0-10.0 **F**ABB

The conductors used for the manufacture of AXOJUMP® flat cables are made of tin plated copper. AXON' also offers bare copper conductors with gold plating at exposed ends : a flash of gold is applied over a nickel underlayer.

● Static version **S**

PITCH (mm)	WIDTH (mm)	THICKNESS (mm)	RESISTANCE AT 20°C Ω/Km
0.50	0.30	0.10	730 MAX.
0.80	0.50		400 MAX.
1.00	0.70		280 MAX.
1.25/1.27	0.80		250 MAX.
2.54	1.57		0.076

● Flexible version **F**

PITCH (mm)	WIDTH (mm)	THICKNESS (mm)	RESISTANCE AT 20°C Ω/Km
0.30	0.15	0.05	3164 MAX.
0.50	0.30		1464 MAX.
0.80	0.50		800 MAX.
1.00	0.70		520 MAX.
1.25/1.27	0.80		450 MAX.



▲ FLAT TIN PLATED COPPER CONDUCTOR

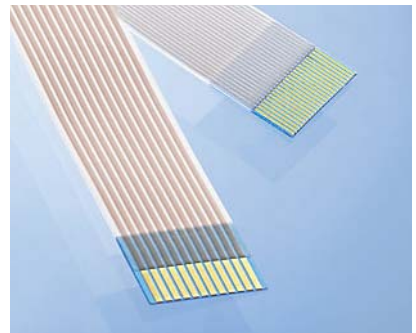

▲ GOLD PLATING AT EXPOSED ENDS

● Extra flexible version **E** (E tape only)

PITCH (mm)	WIDTH (mm)	THICKNESS (mm)	RESISTANCE AT 20°C Ω/Km
0.50	0.30	0.035	1730 MAX.
0.80	0.50		1030 MAX.
1.00	0.70		720 MAX.
1.25/1.27	0.80		643MAX.

● Ultra flexible version **U** (E tape only)

PITCH (mm)	WIDTH (mm)	THICKNESS (mm)	RESISTANCE AT 20°C Ω/Km
1.00	0.60	0.025	1500 MAX.
1.25/1.27	0.80	0.025	970 MAX.

● Other types of conductors are available upon request.

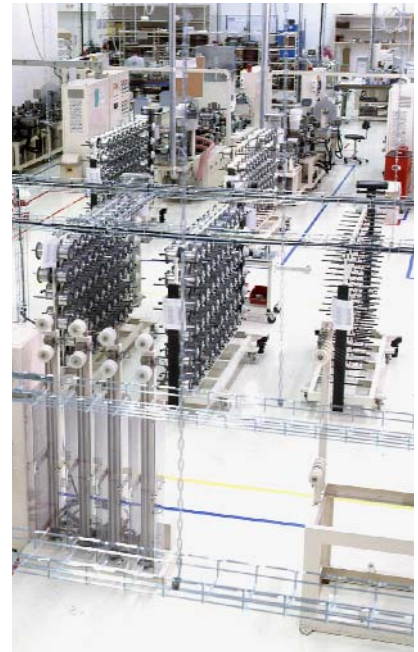

▲ CONDUCTOR MANUFACTURING

The following table shows the possible conductor/ tape combinations.

TYPE OF CONDUCTOR	TYPE OF TAPE											
	S	L	H	M	N	P	E	T	X	Y	Z	
S	OK	OK	OK	OK		OK		OK	OK	OK	OK	
F	OK	OK	OK	OK		OK			OK	OK	OK	
E					OK		OK					
U					OK		OK					

FLEX LIFE

The flex life of AXON's FFC's depends on the choice of conductor / insulation tape combination.

To respond to the different requirements of flex life in dynamic applications, AXON' offers a range of FFC's to withstand an increasing number of flex cycles. The following table summarizes flex tests which have been carried out on a 1.00 mm pitch FFC sample on a bend radius of 10 mm.

The sample is fitted between two trays with a bend radius of 10 mm. The bottom tray moves and the top one remains still. The cycle is repeated until one conductor breaks.

TYPE OF FFC	CONDUCTOR μm	TYPE OF TAPE	MINIMUM NUMBER OF CYCLES BEND RADIUS 10 mm
FLEXIBLE VERSION	50	S	1, 500, 000
EXTRA-FLEXIBLE VERSION	35	E	2, 500, 000
ULTRA-FLEXIBLE VERSION	25	E	more than 70, 000, 000



▲ FLEX LIFE TEST

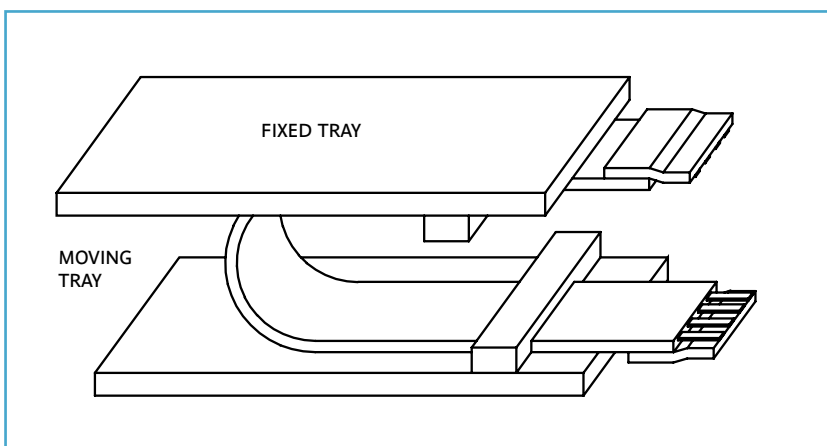

DIMENSIONS

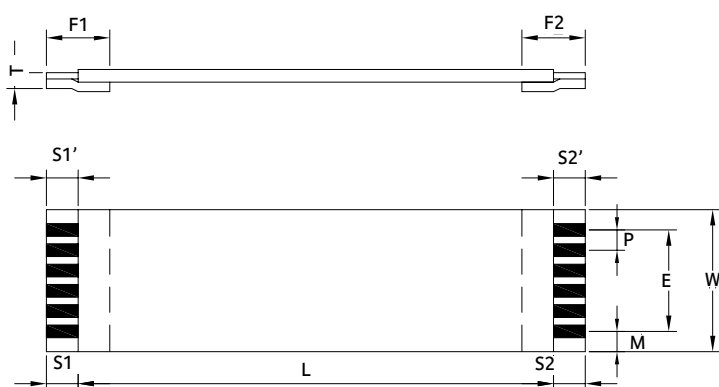

▲ DECREASING PITCHES

PITCH : P (mm)	0.30 *	0.50	0.80	1.00	1.25	2.54
NUMBER OF CONDUCTORS : N	11-51	6-50	4-50	4-99	3-79	2-38
SPAN : E (mm)	(N-1) 0.30	(N-1)0.50	(N-1)0.80	(N-1)1.00	(N-1)1.25	(N-1)2.54
WIDTH : W (mm)	(N+1) 0.30	(N+1)0.50	(N+1)0.80	(N+1)1.00	(N+1)1.25	(N+1)2.54
MARGIN : M (mm)	0.30	0.50	0.80	1.00	1.25	2.54

STRIP LENGTH : S1, S2 (mm)

Tape S and L : according to reference and ± 0.8
Tape H-M-N-P-E-T-X : according to reference and ± 1

REINFORCEMENT LENGTH : F1, F2 (mm)

According to reference and ± 2

INSULATED LENGTH : L (mm)

According to reference and

40 TO 60 ± 2
61 TO 100 ± 3
101 TO 200 ± 4
201 TO 500 ± 5

20 TO 60 ± 2
61 TO 100 ± 3
101 TO 200 ± 4
201 TO 3999 ± 5
4000 TO 5999 ± 10
6000 TO 9999 ± 15

THICKNESS AT THE CABLES END : T (mm)

0.20 mm

0.30 mm

CABLE THICKNESS : t (mm)

0.30 (with static conductors)
0.22 (with flexible conductors)
0.20 for 0.30 mm pitch

STRIP LENGTH DISCREPANCY :
S-S' (mm)

max. 0.20

max. 0.30

max. 0.30

max. 0.40

max. 0.40

max. 0.40

MISALIGNMENT OF THE TWO SIDES OF
INSULATION TAPE AT REINFORCEMENT
END : (mm)

max. 0.70

* : available with S tape only

SHIELDING

● FFC with aluminium shielding

Aluminum tape shielding is possible on flat cables 7 to 30 mm wide and 60 to 1100 mm long.

● Version S

ALUMINUM SHIELDED VERSION WITHOUT GROUNDING

Example of reference : FFC1.00A20/0075S5.0-5.0-10.0-10.0-FABB/**S**

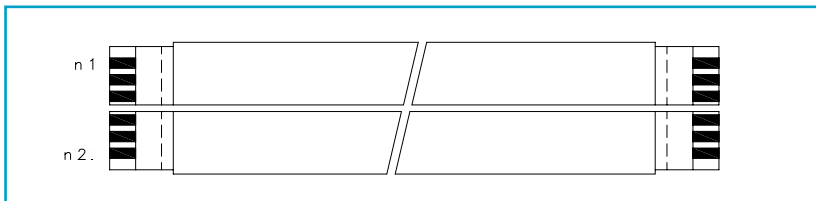

▲ ALUMINIUM SHIELDING

● Version G

ALUMINUM SHIELDED VERSION WITH GROUNDING (MAX. 3 GROUNDS).

Example of reference : FFC1.00A20/0075S5.0-5.0-10.0-10.0-FABB/**G2-7**

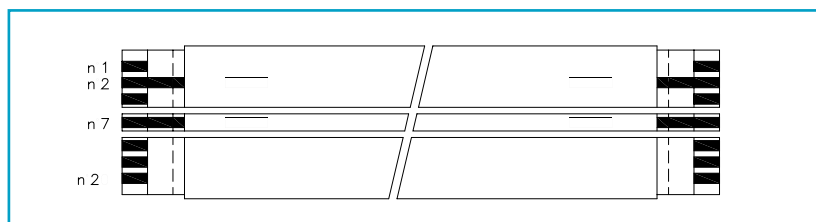

A punch connects the aluminium tape to the specified stripped conductor.

● FFC with painted shield

Painted shield is possible on flat cables 3.5 to 30 mm wide and 50 to 650 mm long. Other widths and/or lengths can be offered upon request.

● Version PS

PAINTED SHIELDED VERSION WITHOUT GROUNDING

Example of reference : FFC1.00A20/0075S5.0-5.0-10.0-10.0FABB/**PS**

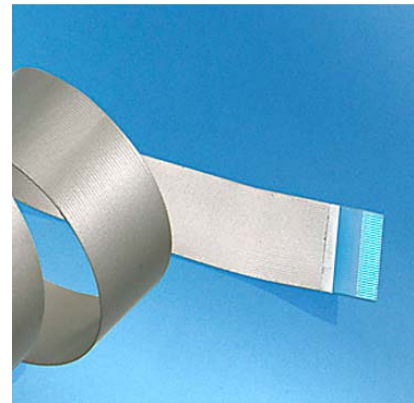
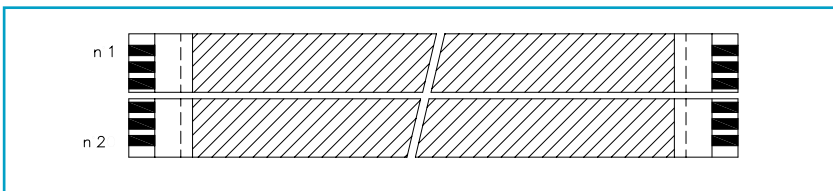

▲ PAINTED SHIELD

● Version PG

PAINTED SHIELDED VERSION WITH GROUNDS (NO LIMIT FOR THE NUMBER OF GROUNDS)

Example of reference : FFC1.00A20/0075S5.0-5.0-10.0-10.0FABB/**PG2-7**

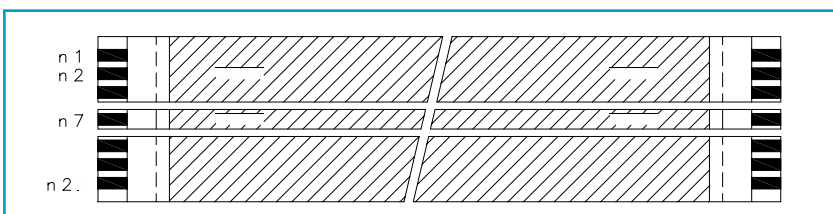

Laser stripped areas of the specified conductor (s) are in contact with the shielding.

Special products

SPECIAL PRODUCTS

Responding to a growing demand for custom designed specialty products, AXON' has developed numerous special versions of flat cable :

- folded,
- non-standard or hybrid pitches,
- special insulation tapes,
- adhesive tape sticking,
- crimped contacts,
- punchings, markings, slittings, stripings and special mounting devices.

● FOLDS

- allow to adapt to the equipment's shape.
- easy to install.

● PUNCHING

- facilitate positioning of the cable in the equipment.
- polarization (POKA YOKE).

● NOTCHES

- cable retained in the connector.
- improves the contact of the conductors to the connector.

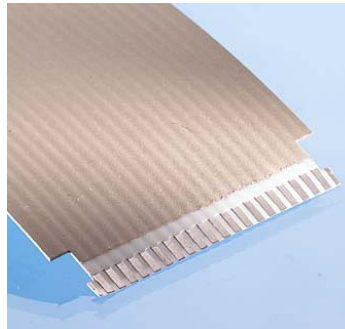

▲ NOTCHES

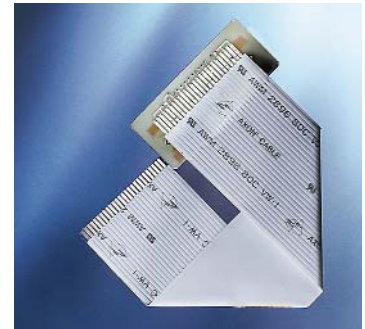

▲ FOLDED AND SOLDERED



▲ CRIMPED CONTACTS



▲ PUNCHINGS

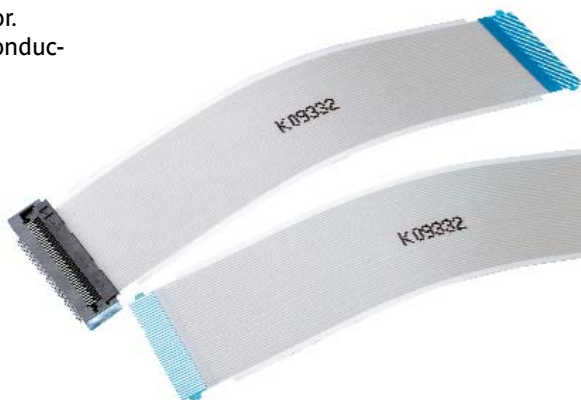

▲ INK JET MARKING / FH 28 PUNCHING

SPECIAL PRODUCTS

● SLITTING

- connection to PCB situated at different level or on different parts of the PCB.
- facilitate positioning of the cable in the equipment.
- polarization (POKA YOKE).



▲ LINE MARKING ON THE REINFORCEMENT

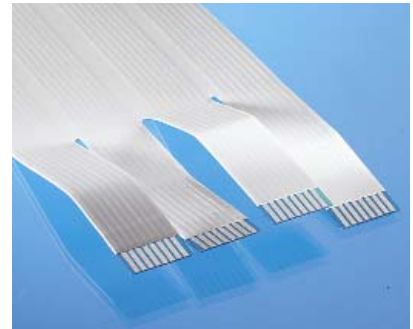

▲ SLITTINGS

● SPECIFIC MARKINGS

- identification of the product.
- polarization (POKA YOKE).
- marking of text, lines, symbols etc.

● OTHER CUSTOM OPTIONS

Additional insulation layers :

- Increase abrasion resistance.
- Improve electrical insulation.
- Facilitate hot bar soldering.
- Mounting brackets.
- Strain relieving solder joints.

AXON' is at your disposal for any special design.

We can adapt our products to your manufacturing process.

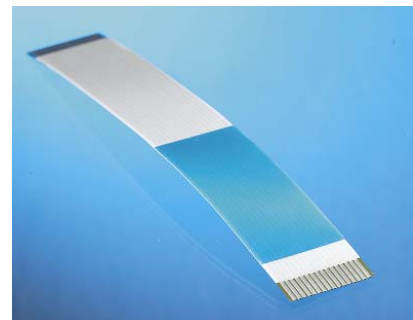

▲ ADDITIONAL REINFORCEMENT



▲ MOUNTING BRACKETS

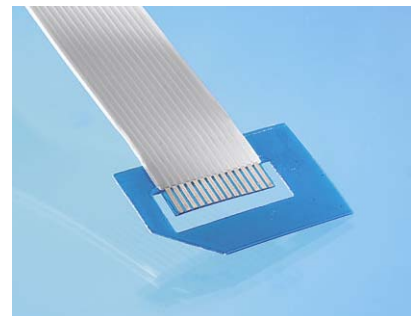

▲ SPECIFIC POSITIONING DEVICE



HEADQUARTERS : FRANCE
AXON' CABLE S.A.S.
ROUTE DE CHALONS EN CHAMPAGNE
51210 MONTMIRAIL - FRANCE
TEL. : +33 3 26 81 70 00 - FAX : +33 3 26 81 28 83
e-mail : sales@axon-cable.com - [http:// www.axon-cable.com](http://www.axon-cable.com)

● **CHINA**

AXON' INTERCONNECT LIMITED
HIGH TECH INDUSTRIAL PARK,
CHANG BAO XI ROAD
RONGGUI, 528306
SHUNDE, GUANGDONG
TEL. : +86 757 2838 7200
FAX : +86 757 2838 7212
e-mail : sales@axon-interconnect.com

● **GERMANY**

AXON' KABEL GmbH
POSTFACH 1131 – 71201 LEONBERG
HERTICHSTR. 23 – 71229 LEONBERG
TEL. : +49 7152 97992-0
FAX : +49 7152 97992-7
e-mail : sales@axon-cable.de

● **HUNGARY**

AXON' KÁBELGYÁRTÓ KFT.
KECSKEMÉT H-6000,
WEBER EDE U. 10/A
TEL. : +36 76 508 195
FAX : +36 76 508 196
e-mail : axon@axon-cable.hu

● **JAPAN**

AXON' CABLE JAPAN OFFICE
GOTANDA N-BUILDING, 3F
2-24-9, NISHI GOTANDA
SHINAGAWA-KU – TOKYO 141-0031
TEL. : +81 3 3493 4736
FAX : +81 3 3493 4897
e-mail : axon-jap@muse.ocn.ne.jp

● **LATVIA**

AXON' CABLE SIA
VIŠKU IELA, 21
DAUGAVPILS - LV-5410
TEL. : +371 540 78 91
FAX : +371 787 11 68
e-mail : axon@axoncable.lv

● **MEXICO**

AXON' INTERCONEX, S.A. de C.V.
TIERRAS Y AGUAS 101. COL. CASABLANCA
76030 QUERÉTARO, QRO
TEL. : +52 442 2152713
FAX : +52 442 2160316
e-mail : n.rodriguez@axoncable.com

● **SPAIN**

AXON' CABLE SPANISH OFFICE
C/CAPITÁN HAYA, N° 1, PLANTA 15
28020 MADRID
TEL. : +34 91 418 43 46
FAX : +34 91 556 28 80
e-mail : sales@axon-cable.com

● **UNITED KINGDOM**

AXON' CABLE Ltd
RIDGE WAY
DONIBRISTLE INDUSTRIAL PARK
HILLEND – DUNFERMLINE
FIFE – KY11 9JN
TEL. : +44 1383 821081
FAX : +44 8700 517257
e-mail : sales@axon-cable.co.uk

● **USA**

AXON' CABLE INC.
1314 PLUM GROVE ROAD
SCHAUMBURG, IL. 60173
TEL. : +1 847 230 7800
FAX : +1 847 230 7849
e-mail : sales@axoncable.com
[http ://www.axoncable.com](http://www.axoncable.com)

